

# SPEC

Spec No.	TQ3C-8EAF0-E1DEX65-00
Date	June 28, 2010

**TYPE : TCG075VGLDD-C50**  
< 7.5 inch VGA transmissive color TFT  
with LED backlight and touch panel >

## CONTENTS

1. Application
2. Construction and outline
3. Mechanical specifications
4. Absolute maximum ratings
5. Electrical characteristics
6. Optical characteristics
7. Interface signals
8. Input timing characteristics
9. Backlight characteristics
10. Design guidance for analog touch panel
11. Lot number identification
12. Warranty
13. Precautions for use
14. Reliability test data
15. Outline drawing



KYOCERA CORPORATION  
KAGOSHIMA HAYATO PLANT  
LCD DIVISION

This specification is subject to change without notice.  
Consult Kyocera before ordering.

Original Issue Date	Designed by: Engineering dept.			Confirmed by: QA dept.	
	Prepared	Checked	Approved	Checked	Approved
June 28, 2010	S. Maezuru	Y. Yamazaki	M. Fujitani	I. Hamada	H. Aoki

Spec No. TQ3C-8EAF0-E1DEX65-00	Part No. TCG075VGLDD-C50	Page -
-----------------------------------	-----------------------------	-----------

---

## **Warning**

1. This Kyocera LCD module has been specifically designed for use only in electronic devices and industrial machines in the area of audio control, office automation, industrial control, home appliances, etc. The module should not be used in applications where the highest level of safety and reliability are required and module failure or malfunction of such module results in physical harm or loss of life, as well as enormous damage or loss. Such fields of applications include, without limitation, medical, aerospace, communications infrastructure, atomic energy control. Kyocera expressly disclaims any and all liability resulting in any way to the use of the module in such applications.
  
2. Customer agrees to indemnify, defend and hold Kyocera harmless from and against any and all actions, claims, damages, liabilities, awards, costs, and expenses, including legal expenses, resulting from or arising out of Customer's use, or sale for use, or Kyocera modules in applications.

## **Caution**

1. Kyocera shall have the right, which Customer hereby acknowledges, to immediately scrap or destroy tooling for Kyocera modules for which no Purchase Orders have been received from the Customer in a two-year period.

Spec No. TQ3C-8EAF0-E1DEX65-00	Part No. TCG075VGLDD-C50	Page -
-----------------------------------	-----------------------------	-----------

**Revision record**

Date		Designed by : Engineering dept.			Confirmed by : QA dept.	
		Prepared	Checked	Approved	Checked	Approved
Rev.No.	Date	Page	Descriptions			

## 1. Application

This document defines the specification of TCG075VGLDD-C50. (RoHS Compliant)

## 2. Construction and outline

LCD	: Transmissive color dot matrix type TFT
Backlight system	: LED
Polarizer	: Glare treatment
Additional circuit	: Timing controller, Power supply (3.3V input) (without constant current circuit for LED Backlight)
Touch panel	: Analog type(Glass/Glass)
Surface film	: Glare Anti-finger print treatment

## 3. Mechanical specifications

### 3-1. LCD

Item	Specification	Unit
Outline dimensions 1)	173(W)×133(H)×7.89(D)	mm
Active area	151.68(W)×113.76(H) (18.9cm/7.5 inch(Diagonal))	mm
Effective viewing area	153.7(W)×115.8(H)	mm
Dot format	640×(B,G,R)(W)×480(H)	dot
Dot pitch	0.079(W)×0.237(H)	mm
Base color 2)	Normally White	-
Mass	(TBD)	g

- 1) Projection not included. Please refer to outline for details.
- 2) Due to the characteristics of the LCD material, the color varies with environmental temperature.

### 3-2. Touch panel

Item	Specification	Unit
Input	Radius-0.8 stylus or Finger	-
Actuation Force	(TBD)	N
Operating life	Striking(Finger-input) 1)	(TBD) hits
	Sliding(Stylus-input) 2)	(TBD) characters
Transmittance	Typ.80(at full wavelength)	%
Reflectance	Typ.15(550nm)	%
Surface hardness	3H or more(Pencil hardness)	-

Spec No.	Part No.	Page
TQ3C-8EAF0-E1DEX65-00	TCG075VGLDD-C50	2

1) Striking test condition

Testing rod : Silicon rubber (Hardness: (TBD)<sup>o</sup>), Tip : R =(TBD)  
 Testing location : In active area  
 Input voltage : DC5V  
 Load : (TBD)N  
 Cycle : (TBD)hits/sec  
 Judgment : No defect in function  
 : No appearance defect which causes trouble to use.  
 \*Dents, blurs and marks on surface film : neglected

2) Sliding test condition

Testing rod : Polyacetal resin, Tip : R = (TBD)  
 Testing location : In active area  
 Input voltage : DC5V  
 Load : (TBD)N  
 Input length : (TBD)mm  
 Input speed : (TBD)mm/sec  
 Sliding times : 10mm sliding (back and forth) counts as 2 times.  
 Judgment : No defect in function  
 : No appearance defect which causes trouble to use.  
 \*Dents, blurs and marks on surface film : neglected

## 4. Absolute maximum ratings

### 4-1. Electrical absolute maximum ratings

Item	Symbol	Min.	Max.	Unit
Supply voltage	V <sub>DD</sub>	0	4.0	V
Input signal voltage 1)	V <sub>IN</sub>	-0.3	6.0	V
LED forward current 2) 3)	I <sub>F</sub>	-	35	mA
Supply voltage for touch panel	V <sub>TP</sub>	0	6.0	V
Input current of touch panel	I <sub>TP</sub>	0	0.5	mA

- 1) Input signal : CK, R0 ~ R5, G0 ~ G5, B0 ~ B5, H<sub>SYNC</sub>, V<sub>SYNC</sub>, ENAB, R/L, U/D
- 2) For each "AN-CA"
- 3) Do not apply reversed voltage.

### 4-2. Environmental absolute maximum ratings

Item	Symbol	Min.	Max.	Unit
Operating temperature 1)	T <sub>OP</sub>	-20	70	°C
Storage temperature 2)	T <sub>STO</sub>	-30	80	°C
Operating humidity 3)	H <sub>OP</sub>	10	4)	%RH
Storage humidity 3)	H <sub>STO</sub>	10	4)	%RH
Vibration	-	5)	5)	-
Shock	-	6)	6)	-

- 1) Operating temperature means a temperature which operation shall be guaranteed. Since display performance is evaluated at 25°C, another temperature range should be confirmed.
- 2) Temp. = -30°C < 48h , Temp. = 80°C < 168h  
Store LCD at normal temperature/humidity. Keep them free from vibration and shock.  
An LCD that is kept at a low or a high temperature for a long time can be defective due to other conditions, even if the low or high temperature satisfies the standard.  
(Please refer to "Precautions for Use" for details.)
- 3) Non-condensing
- 4) Temp. 40°C, 85%RH Max.  
Temp. > 40°C, Absolute humidity shall be less than 85%RH at 40°C.
- 5)

Frequency	10 ~ 55 Hz	Acceleration value (0.3 ~ 9 m/s <sup>2</sup> )
Vibration width	0.15mm	
Interval	10-55-10 Hz	1 minutes

2 hours in each direction X, Y, Z (6 hours total)

EIAJ ED-2531

- 6) Acceleration: 490 m/s<sup>2</sup>, Pulse width: 11 ms  
3 times in each direction: ±X, ±Y, ±Z  
EIAJ ED-2531

## 5. Electrical characteristics

### 5-1. LCD

Temp. = -20 ~ 70°C

Item	Symbol	Condition	Min.	Typ.	Max.	Unit
Supply voltage 1)	$V_{DD}$	-	3.0	3.3	3.6	V
Current consumption	$I_{DD}$	2)	-	160	210	mA
Permissive input ripple voltage	$V_{RP}$	-	-	-	100	mVp-p
Input signal voltage 3)	$V_{IL}$	"Low" level	0	-	$0.3V_{DD}$	V
	$V_{IH}$	"High" level	$0.7V_{DD}$	-	$V_{DD}$	V

1)  $V_{DD}$ -turn-on conditions

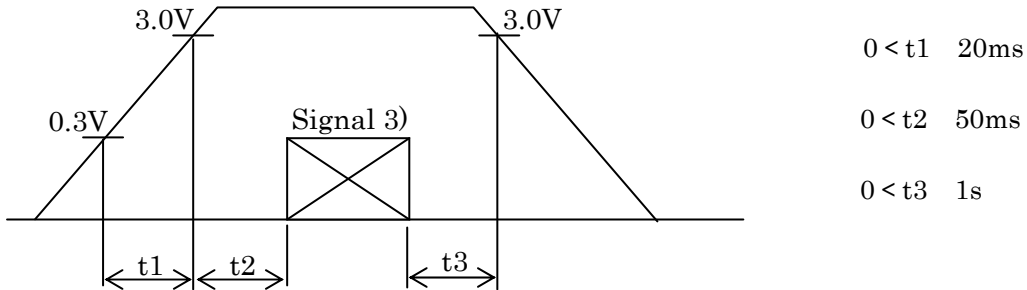

2) Display pattern:

$V_{DD} = 3.3\text{V}$ , Temp. = 25°C

```

123 456 789  . . . . . 1918 1919 1920(dot)
1
2
3
:
:
:
479
480
(dot)

```

3) Input signal : CK, R0 ~ R5, G0 ~ G5, B0 ~ B5, H<sub>SYNC</sub>, V<sub>SYNC</sub>, ENAB, R/L, U/D

5-2. Touch panel

Item	Symbol	Condition	Min.	Typ.	Max.	Unit
Supply voltage for touch panel	V <sub>TP</sub>	-	-	5.0	-	V
Terminal resistance	xL-xR	-	500	-	1500	Ω
	yU-yL	-	200	-	1000	Ω
Linearity	2)	-	less than ±2.5			%
Insulation resistance	3)	DC25V	50	-	-	MΩ
Chattering	4)	at ON/OFF	less than 10			ms

- 1) Resistance between terminal xL and xR, or between yU and yL
- 2) Apply 5VDC to the terminal xL-xR, and measure the output voltage at terminal y when a random input is applied in the active area. Measure the difference between the output and theoretical voltages. (Measure the actual voltage at the terminal using the same method.)

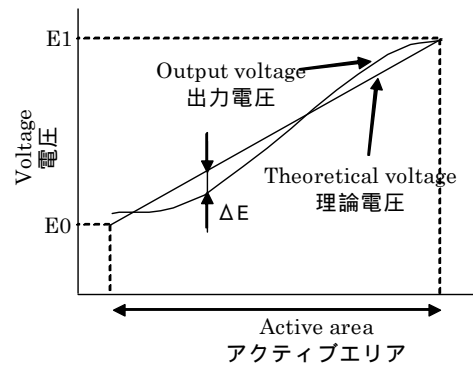

$$\text{Linearity (リニアリティ) (\%)} = \frac{E_{\text{max}}}{E_1 - E_0}$$

- 3) Resistance between the upper and lower terminals.
- 4) Apply 5VDC to the terminal xL-xR, and measure the oscillation at terminal y when applying a random input in the active area. (Measure the oscillation at terminal x using the same method.)

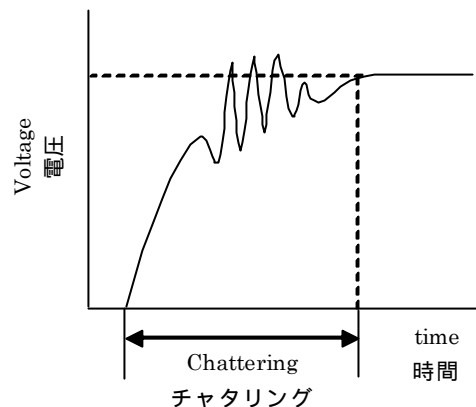

## 6. Optical characteristics

Measuring spot = 6.0mm, Temp. = 25°C

Item	Symbol	Condition	Min.	Typ.	Max.	Unit	
Response time	Rise	$\tau_r$	= =0°	-	15	-	ms
	Down	$\tau_d$	= =0°	-	20	-	ms
Viewing angle range View direction : 6 o'clock (Gray inversion)	UPPER	CR 5	= =0°	-	80	-	deg.
	LOWER			-	80	-	
	LEFT			-	80	-	deg.
	$\phi$ RIGHT			-	80	-	
Contrast ratio	CR	= =0°	300	500	-	-	
Brightness	L	IF=13.5mA/Line	(220)	(320)	-	cd/m <sup>2</sup>	
Chromaticity coordinates	Red	x	= =0°	0.55	0.60	0.65	-
		y		0.31	0.36	0.41	
	Green	x	= =0°	0.29	0.34	0.39	
		y		0.54	0.59	0.64	
	Blue	x	= =0°	0.10	0.15	0.20	
		y		0.07	0.12	0.17	
	White	x	= =0°	0.27	0.32	0.37	
		y		0.29	0.34	0.39	

### 6-1. Definition of contrast ratio

$$CR(\text{Contrast ratio}) = \frac{\text{Brightness with all pixels "White"}}{\text{Brightness with all pixels "Black"}}$$

### 6-2. Definition of response time

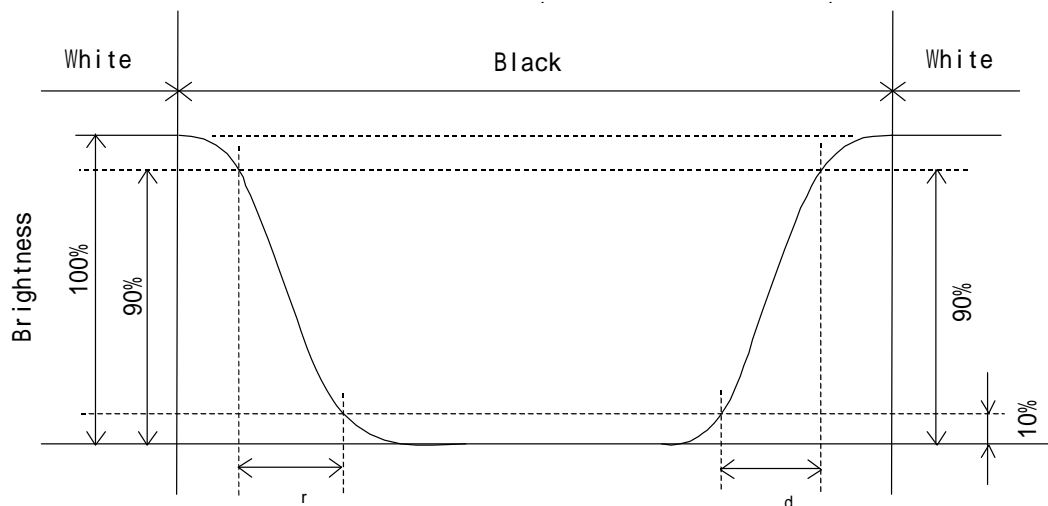

6-3. Definition of viewing angle

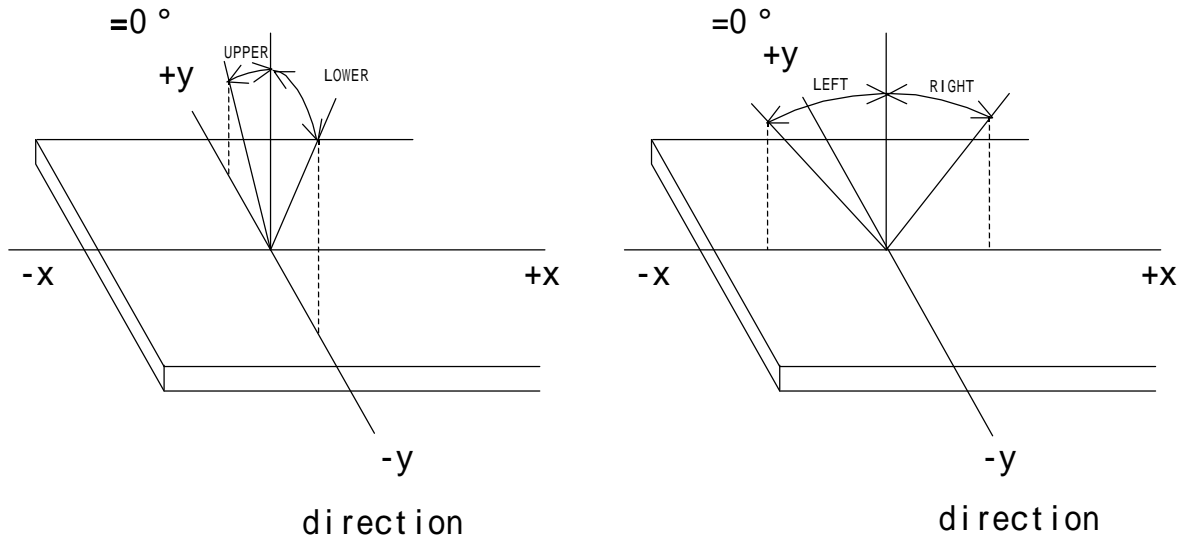

6-4. Brightness measuring points

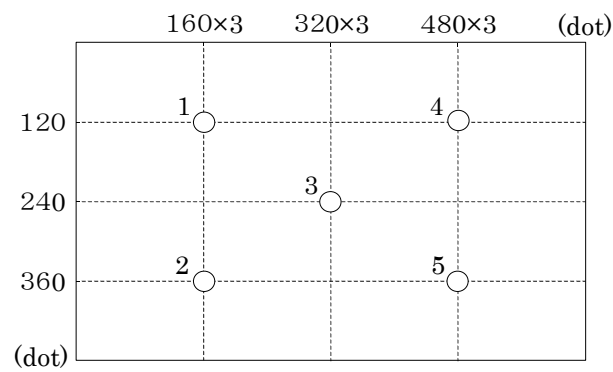

- 1) Rating is defined on the average in the viewing area. (measured point 1 ~ 5)
- 2) Measured 30 minutes after the LED is powered on. (Ambient temp. = 25°C)

## 7. Interface signals

### 7-1. LCD

No.	Symbol	Description	I/O	Note
1	GND	GND	-	
2	CK	Clock signal for sampling each data signal	I	
3	H <sub>SYNC</sub>	Horizontal synchronous signal (negative)	I	
4	V <sub>SYNC</sub>	Vertical synchronous signal (negative)	I	
5	GND	GND	-	
6	R0	RED data signal (LSB)	I	
7	R1	RED data signal	I	
8	R2	RED data signal	I	
9	R3	RED data signal	I	
10	R4	RED data signal	I	
11	R5	RED data signal (MSB)	I	
12	GND	GND	-	
13	G0	GREEN data signal (LSB)	I	
14	G1	GREEN data signal	I	
15	G2	GREEN data signal	I	
16	G3	GREEN data signal	I	
17	G4	GREEN data signal	I	
18	G5	GREEN data signal (MSB)	I	
19	GND	GND	-	
20	B0	BLUE data signal (LSB)	I	
21	B1	BLUE data signal	I	
22	B2	BLUE data signal	I	
23	B3	BLUE data signal	I	
24	B4	BLUE data signal	I	
25	B5	BLUE data signal (MSB)	I	
26	GND	GND	-	
27	ENAB	Signal to settle the horizontal display position (positive)	I	1)
28	V <sub>DD</sub>	3.3V power supply	-	
29	V <sub>DD</sub>	3.3V power supply	-	
30	R/L	Horizontal display mode select signal L : Normal , H : Left / Right reverse mode	I	2)
31	U/D	Vertical display mode select signal H : Normal , L : Up / Down reverse mode	I	2)
32	NC	No connect	-	
33	CA1	Cathode 1	-	
34	CA2	Cathode 2	-	
35	CA3	Cathode 3	-	
36	CA4	Cathode 4	-	
37	AN1	Anode 1	-	
38	AN2	Anode 2	-	
39	AN3	Anode 3	-	
40	AN4	Anode 4	-	

LCD connector : IMSA-9681S-40A-GF (IRISO)  
Recommended matching FFC or FPC : 0.5mm pitch

- 1) The horizontal display start timing is settled in accordance with a rising timing of ENAB signal.  
In case ENAB is fixed "Low", the horizontal start timing is determined.  
Don't keep ENAB "High" during operation.

2)



R/L = L  
U/D = H



R/L = H  
U/D = H



R/L = L  
U/D = L

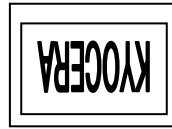

R/L = H  
U/D = L

## 7-2. Touch panel

No.	Symbol	Description
1	yU	y-Upper terminal
2	xL	x-Left terminal
3	yL	y-Lower terminal
4	xR	x-Right terminal

Touch panel side connector : 1.25mm pitch  
 Recommended matching connector : 04FFS-SP-GB-TF(LF)(SN) (JST)  
 : 00-8370-049-000-888+ (ELCO)

## 8. Input timing characteristics

### 8-1. Timing characteristics

Item		Symbol	Min	Typ	Max	Unit	Note
Clock	Frequency	1/Tc	22.66	25.18	27.69	MHz	
	Duty ratio	Tch/Tc	40	50	60	%	
Data	Set up time	Tds	5	-	-	ns	
	Hold time	Tdh	10	-	-	ns	
Horizontal sync. signal	Cycle	TH	30.0	31.8	-	μs	
			770	800	850	clock	
	Pulse width	THp	2	96	200	clock	
Vertical sync. signal	Cycle	TV	515	525	560	line	
	Pulse width	TVp	2	-	34	line	
Horizontal display period		THd	640			clock	
Hsync,-Clock phase difference		THc	10	-	Tc-10	ns	
Hsync-Vsync. phase difference		TVh	2Tc	-	TH-THp-1	ns	
Vertical sync. signal start position		TVs	34			line	
Vertical display period		TVd	480			line	

- 1) In case of lower frequency, the deterioration of the display quality, flicker etc., may occur.

### 8-2. Horizontal display position

Item		Symbol	Min	Typ	Max	Unit	Note
Enable signal	Set up time	Tes	5	-	Tc-10	ns	
	Pulse width	Tep	2	640	TH-10	clock	
H <sub>SYNC</sub> – Enable signal phase difference		The	44	-	TH-664	clock	

- 1) When ENAB is fixed at "Low", the display starts from the data of C104(clock) as shown in 8-5.
- 2) The horizontal display position is determined by ENAB signal.

### 8-3. Vertical display position

- 1) The vertical display position (TVs) is 34th line.
- 2) ENAB signal is independent of vertical display position.

8-4. Input Data Signals and Display position on the screen

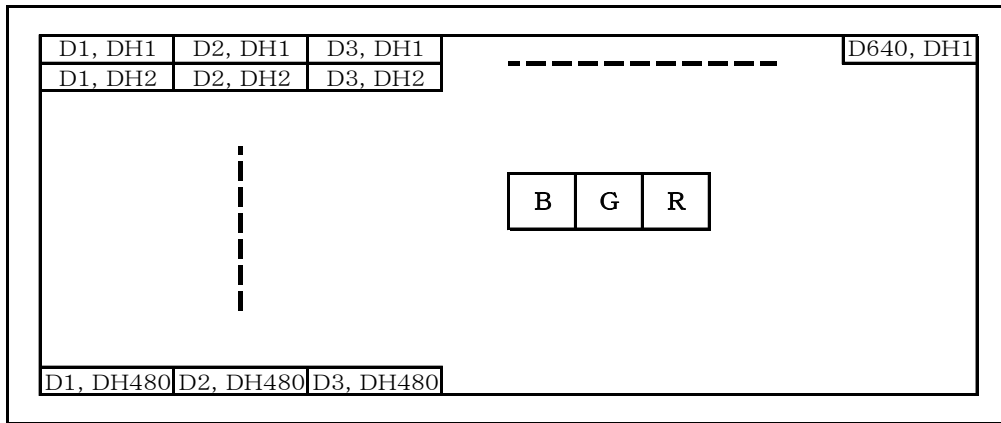

8-5. Input timing characteristics

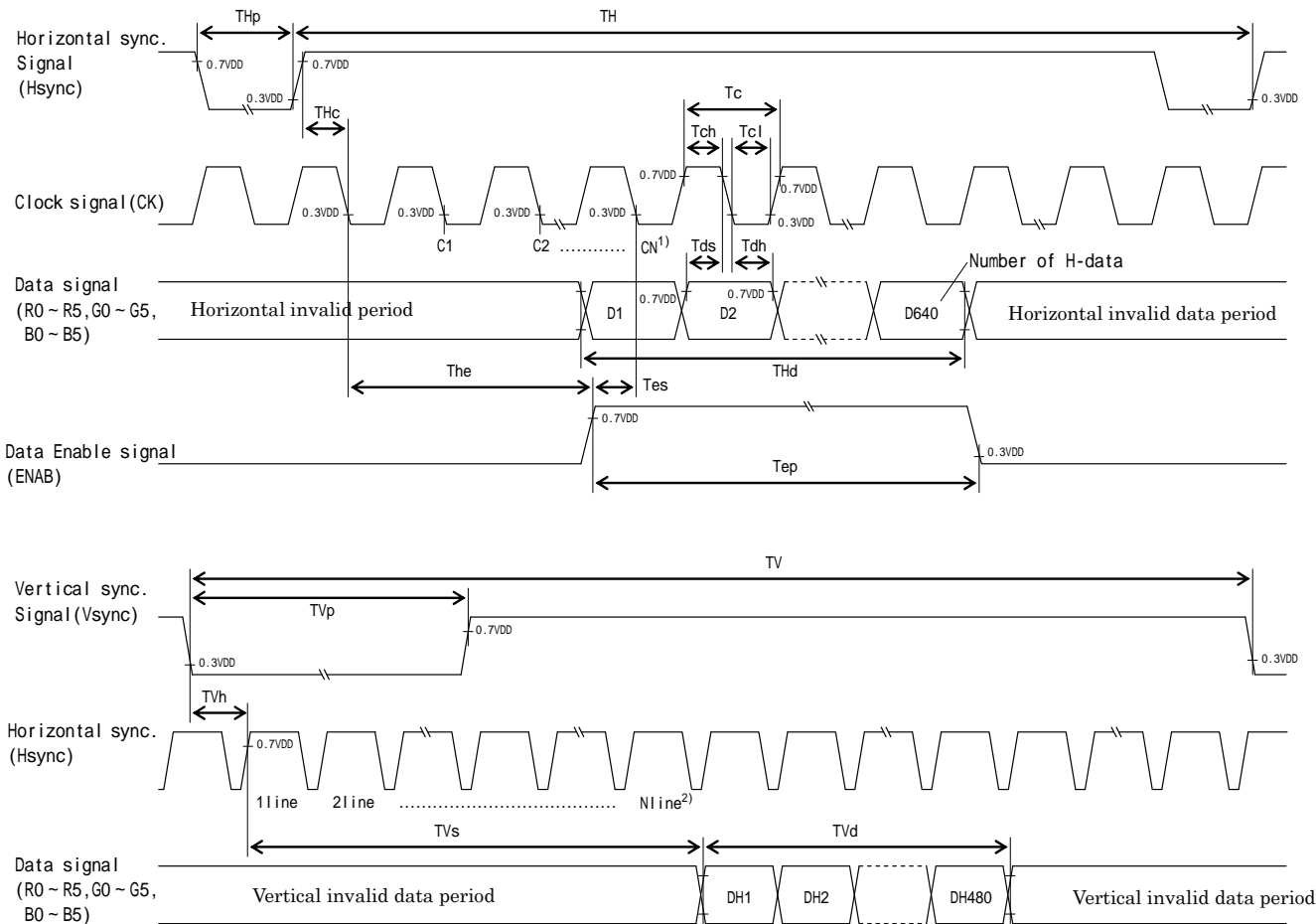

- 1) When ENAB is fixed at "Low", the display starts from the data of C104(Clock).
- 2) The vertical display position(TVs) is fixed at 34th line.

## 9. Backlight characteristics

Item	Symbol	Min.	Typ.	Max.	Unit	Note
Forward current 1)	IF	-	(13.5)	-	mA	Ta=-20 ~ 70°C
Forward voltage 1)	VF	-	(28.5)	(30.3)	V	IF=13.5mA, Ta=-20
		-	(27.5)	(29.3)	V	IF=13.5mA, Ta=25
		-	(26.9)	(28.7)	V	IF=13.5mA, Ta=70
Operating life time 2), 3)	T	-	50,000	-	h	IF=13.5mA, Ta=25

- 1) For each "AN-CA"
- 2) When brightness decrease 50% of minimum brightness.  
The average life of a LED will decrease when the LCD is operating at higher temperatures.
- 3) Life time is estimated data.(Condition : IF=13.5mA, Ta=25 in chamber).
- 4) An input current below 5.0mA may reduce the brightness uniformity of the LED backlight.  
This is because the amount of light from each LED chip is different. Therefore, please evaluate carefully before finalizing the input current.

## 10. Design guidance for analog touch panel

### 10-1. Electrical (In customer's design, please remember the following considerations.)

- 1) Do not use the current regulated circuit.
- 2) Keep the current limit with top and bottom layer.  
(Please refer to "Electrical absolute maximum ratings" for details.)
- 3) Analog touch panel can not sense two points touching separately.
- 4) A contact resistance is appeared at the touch point between top and bottom layer.  
After this resistance has stable read of the touch panel position data.
- 5) Because noise of inverter or peripheral circuits may interfere signal of touch panel itself it is necessary to design carefully in advance to avoid these noise problem.

### 10-2. Software

- 1) Do the "User Calibration".
- 2) "User Calibration" may be needed with long term using.  
Include "User Calibration" menu in your software.
- 3) When drawing a line with a stylus, there may be a slight discontinuity when the stylus passes over a spacer-dot. If necessary, please provide a compensation feature within your software.

### 10-3. Mounting on display and housing bezel

- 1) Do not use an adhesive tape to bond it on the front of touch panel and hang it to the housing bezel.
- 2) This touch panel has an airtight but not watertight structure. Please not to use it for the applications requiring watertight or under the environments occurred condensation. If it is expected to be exposed to the environments that vapor, moisture or other liquids may seep inside a bezel, please be sure to take some measurements for drip-proof or waterproof by using sealing materials on the bezel.
- 3) Please mount the touch panel so that it does not move or slide relative to the LCD, even when vibration or shock is applied and even when high humidity or high temperature may weaken the mounting adhesive.

## 11. Lot number identification

The lot number shall be indicated on the back of the backlight case of each LCD.

TCG075VGLDD-C50 - □□ - □□ - □ MADE IN □□□□□  
 ↓ ↓ ↓ ↓ ↓  
 1 2 3 4 5

No1. - No5. above indicate  
 1. Year code  
 2. Month code  
 3. Date  
 4. Version Number  
 5. Country of origin (Japan or China)

Year	2010	2011	2012	2013	2014	2015
Code	0	1	2	3	4	5

Month	Jan.	Feb.	Mar.	Apr.	May	Jun.
Code	1	2	3	4	5	6

Month	Jul.	Aug.	Sep.	Oct.	Nov.	Dec.
Code	7	8	9	X	Y	Z

## 12. Warranty

### 12-1. Incoming inspection

Please inspect the LCD within one month after your receipt.

### 12-2. Production warranty

Kyocera warrants its LCD's for a period of 12 months from the ship date. Kyocera shall, by mutual agreement, replace or re-work defective LCD's that are shown to be Kyocera's responsibility.

## 13. Precautions for use

### 13-1. Installation of the LCD

- 1) The LCD shall be installed so that there is no pressure on the LSI chips.
- 2) The LCD shall be installed flat, without twisting or bending.
- 3) Please design the housing window so that its edges are between the active area and the effective area of the LCD screen.  
Must maintain a gap between inside of bezel and touch panel to avoid malfunction or electrode damage of touch panel.
- 4) A transparent protection sheet is attached to the touch panel. Please remove the protection film slowly before use, paying attention to static electricity.

### 13-2. Static electricity

- 1) Since CMOS ICs are mounted directly onto the LCD glass, protection from static electricity is required.
- 2) Workers should use body grounding. Operator should wear ground straps.

### 13-3. LCD operation

- 1) The LCD shall be operated within the limits specified. Operation at values outside of these limits may shorten life, and/or harm display images.

### 13-4. Storage

- 1) The LCD shall be stored within the temperature and humidity limits specified.  
Store in a dark area, and protect the LCD from direct sunlight or fluorescent light.
- 2) Always store the LCD so that it is free from external pressure onto it.

### 13-5. Usage

- 1) **DO NOT** store in a high humidity environment for extended periods. Polarizer degradation bubbles, and/or peeling off of the polarizer may result.
- 2) Do not push or rub the touch panel's surface with hard to sharp objects such as knives, or the touch panel may be scratched.
- 3) When the touch panel is dirty, gently wipe the surface with a soft cloth, sometimes moistened by mild detergent or alcohol. If a hazardous chemical is dropped on the touch panel by mistake, wipe it off right away to prevent human contact.
- 4) The touch panel is made of glass. It may break when dropped, or vibrated excessively.  
Usually there is a film on the surface of the glass which would prevent broken glass from scattering, but nevertheless handle it carefully during assembly and treat it gently during use.
- 5) Touch panel edges are sharp, so they have a possibility of cutting your body, for example your finger. Handle the touch panel with enough care to prevent cuts. When you hold the touch panel, put on the protector, for example the gloves which have a strength enough to stand sharpness of touch panel edges.
- 6) Always keep the LCD free from condensation during testing. Condensation may permanently spot or stain the polarizer.
- 7) Do not disassemble LCD because it will result in damage.
- 8) This Kyocera LCD has been specifically designed for use in general electronic devices, but not for use in a special environment such as usage in an active gas. Hence, when the LCD is supposed to be used in a special environment, evaluate the LCD thoroughly beforehand and do not expose the LCD to chemicals such as an active gas.
- 9) Please do not use solid-base image pattern for long hours because a temporary afterimage may appear. We recommend using screen saver etc. in cases where a solid-base image pattern must be used.
- 9) Liquid crystal may leak when the LCD is broken. Be careful not to let the fluid go into your eyes and mouth. In the case the fluid touches your body; rinse it off right away with water and soap.

## 14. Reliability test data

Test item	Test condition	Test time	Judgement
High temp. atmosphere	80°C	240h	Display function : No defect Display quality : No defect Current consumption : No defect
Low temp. atmosphere	-30°C	240h	Display function : No defect Display quality : No defect Current consumption : No defect
High temp. humidity atmosphere	40°C 90% RH	240h	Display function : No defect Display quality : No defect Current consumption : No defect
Temp. cycle	-30°C 0.5h R.T. 0.5h 80°C 0.5h	10cycles	Display function : No defect Display quality : No defect Current consumption : No defect
High temp. operation	70°C	500h	Display function : No defect Display quality : No defect Current consumption : No defect
Point Activation 1)	Silicon rubber, Tip : R =(TBD) Hardness (TBD) <sup>°</sup> Hitting force (TBD)N Hitting speed (TBD) time/s	(TBD)	Touch panel function : No defect Terminal resistance : No defect Linearity : No defect Actuation Force : No defect  No appearance defect which affects touch panel function. 2)
Sliding 1)	Polyacetal resin, Tip : R = (TBD) Load (TBD)N Input length (TBD)mm Input speed (TBD)mm/s	(TBD) 3)	Touch panel function : No defect Terminal resistance : No defect Linearity : No defect Actuation Force : No defect  No appearance defect which affects touch panel function. 2)

- 1) Test in active area.
- 2) Dents, blurs and marks on surface film: neglected.
- 3) 10mm sliding (back and forth) counts as 2 times.
- 4) Temp. cycle test (Heat shock included): the LCD shall be tested after leaving it stabilize at room temperature for 2 hours after the last cycle.
- 5) An operational test was performed after the following conditions. First, the touch panel was left for a certain time under 5V voltages applied (without touch), Then it was left at room temperature (No VDC applied) for 2 hours.
- 6) Each test item uses a test LCD only once. The tested LCD is not used in any other tests.
- 7) The LCD is tested in circumstances in which there is no condensation.
- 8) The reliability test is not an out-going inspection.
- 9) The result of the reliability test is for your reference purpose only.  
The reliability test is conducted only to examine the LCD's capability.

No	Description	Drawn	Checked	Checked	Approved

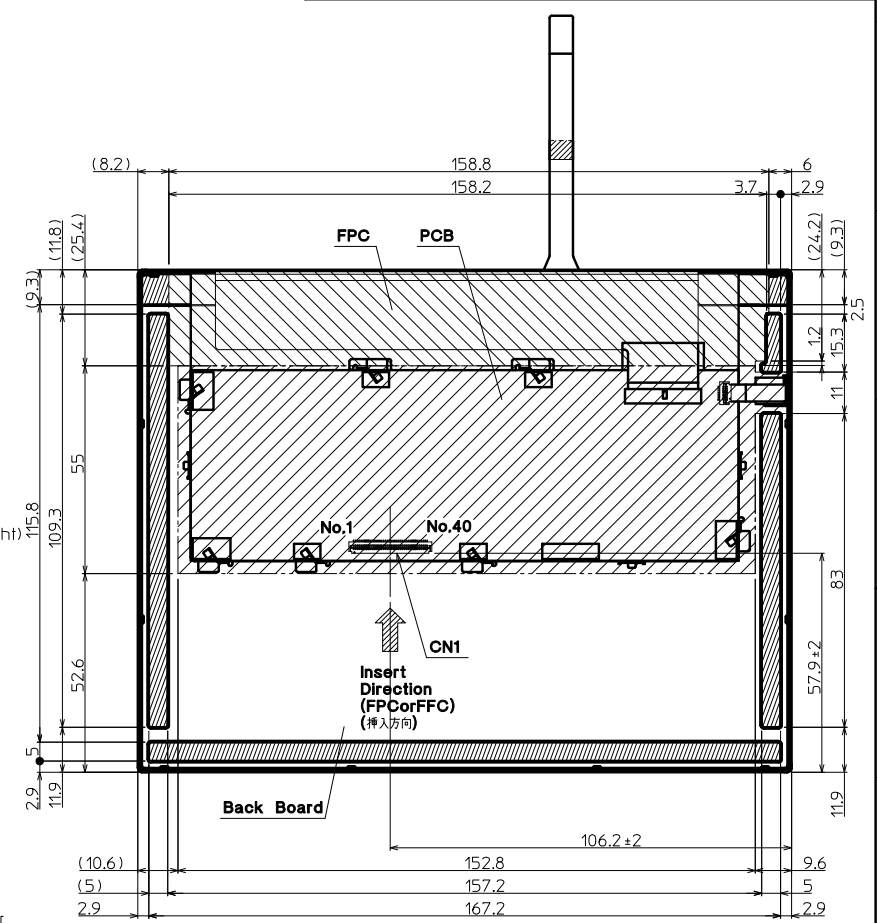
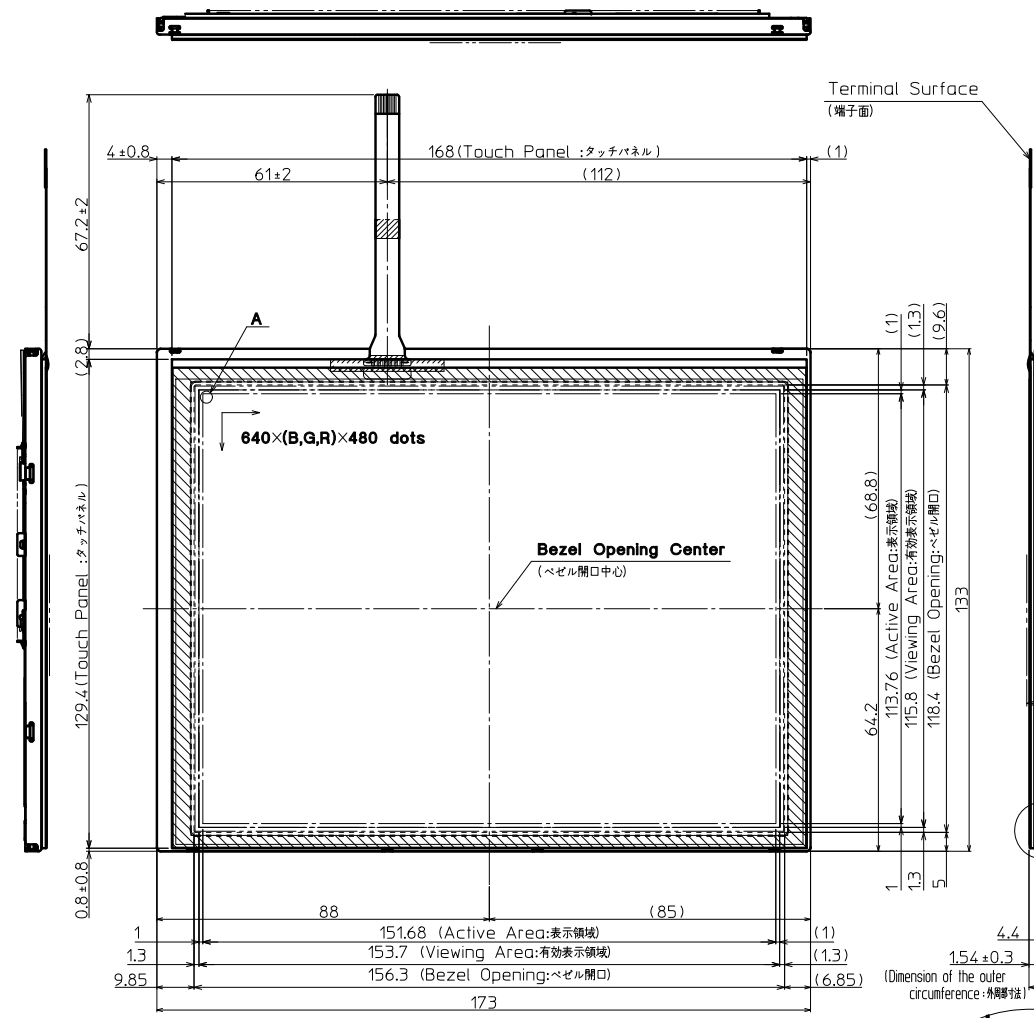

Note. (注記)  
 1. Connector CN1: IMSA-9681S-40A-GF (IRISO) (コネクタ)  
 2. The information of LCD is displayed starting at the upper left hand corner, moving right then down to the lower right hand corner. (LCDにおいて、画像データの表示は左上コーナーから始まり、右へ進み下へ送られ右下コーナーへ向かう。)  
 3. Tolerance without indication: ±0.5 (指示無き公差)

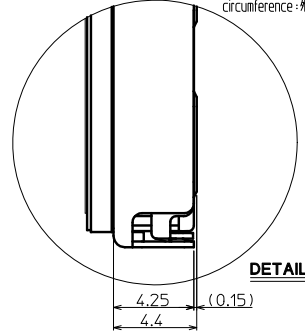

- : Projected part is 0.15mm height from Back Board. (裏面板からの高さ0.15mm)
- : Projected part is 2.1mm height from Back Board. (裏面板からの高さ2.1mm)
- : Projected part is 1.5mm height from Back Board. (裏面板からの高さ1.5mm)

DETAIL A (NTS)  
(Dot Size)

Material 材質	Treatment 処理	Approved '10.03.17	Checked '10.03.16	Checked '10.03.16	Drawn 木口	Scale 1:1(5:1,NTS)	Title TCG075VGLDD	Year-Month-Day '10.03.16	Size 2
Quantity 製作数	Description: 備考	RoHS	朝倉	鶴崎			Outline Dimensions	Drawing No. 121A8023400	1/2

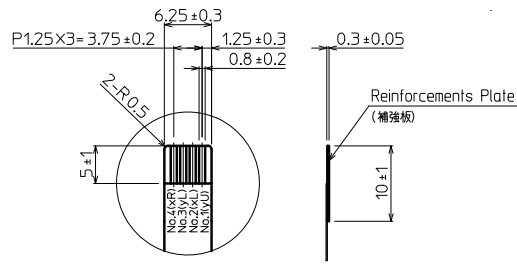

DETAIL C (2:1)

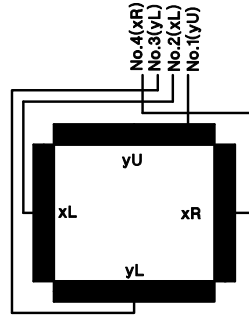

Touch Panel Pin-assign

(Pin-assign from Touch side)  
(タッチパネル ピンアサイン、  
タッチ面側からのピンアサイン)

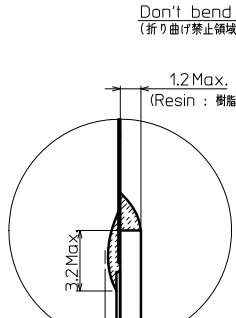

DETAIL D (5:1)

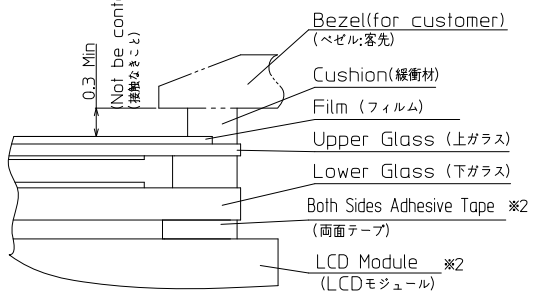

(NTS)

Precaution in use of touch panel.

- (タッチパネル使用上の注意事項)  
※2 In case of assemble to the LCD (LCDに取りつける場合)  
1. Fix touch panel at LCD module and the rear side of touch panel.  
(タッチパネルの固定はLCDモジュール側とタッチパネル裏面とで行なうこと)  
2. Must maintain a gap between inside of bezel and touch panel to avoid malfunction or electrode damage of touch panel.  
(ベゼル内側とタッチパネルの接触厳禁。誤動作や電極破損の原因となります)  
3. Tolerance without indication: ±0.5 (指示無き公差)

Note(注記)

No	Name(名称)	Explanation(説明)
1	T.P.	Touch panel (タッチパネル)
2	T.P. Active Area (T.P.アクティブエリア)	Operating area of touch panel (タッチパネルの動作範囲)
3	T.P. Viewing Area (T.P.ビューイングエリア)	Warranty area of touch panel's appearance (タッチパネルの外観(傷・異物等)保証範囲)

By giving pressure between the active area and the viewing area of the touch panel, there is a possibility that the touch panel will operate.  
(タッチパネルアクティブエリアとタッチパネルビューイングエリア間は荷重をかけた場合は、タッチパネルが動作する可能性があります。)

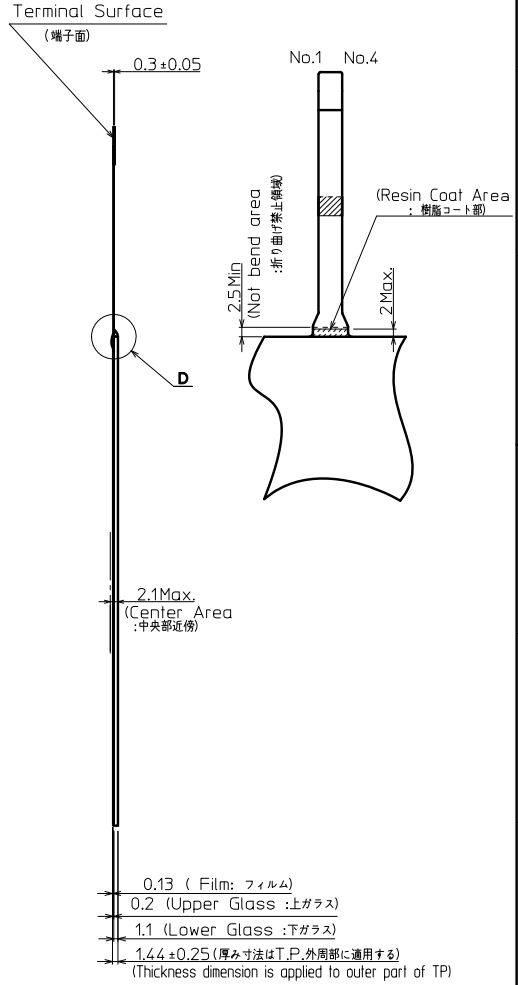
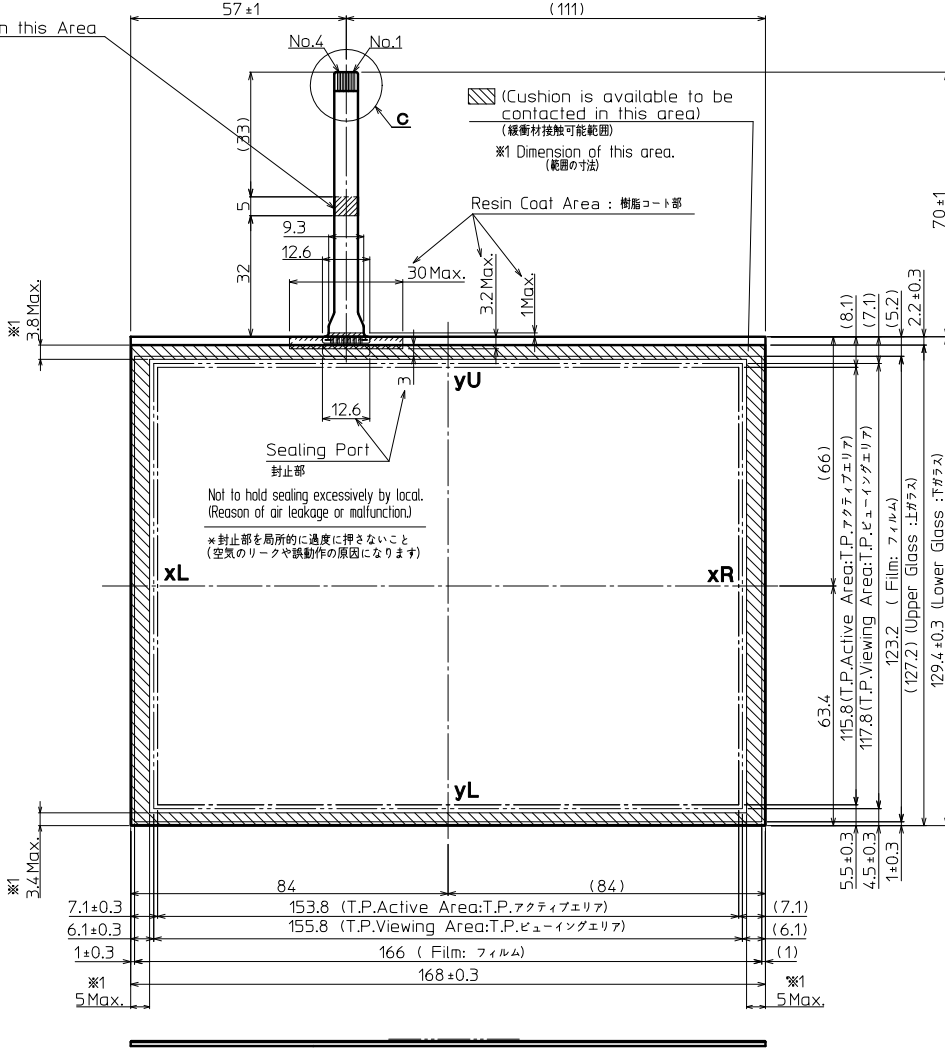

Material 材質	Treatment 処理	Approved '10.03.17	Checked	Checked '10.03.16	Drawn 木口	Scale 1:1(5:1) 2:1(NTS)	Title TCG075VGLDD	KYOCERA	Year-Month-Day '10.03.16	Size 2
Quantity 製作数	Description 備考	朝倉	鶴崎			T.P. Outline Dimensions	Drawing No. 121A8023400			2/2

No	Description	Drawn	Checked	Checked	Approved

Spec No.	TQ3C-8EAF0-E2DEX65-00
Date	June 65, 2010

**KYOCERA INSPECTION STANDARD**

**TYPE : TCG075VGLDD-C50**

KYOCERA CORPORATION  
KAGOSHIMA HAYATO PLANT  
LCD DIVISION

Original Issue Date	Designed by : Engineering dept.			Confirmed by : QA dept.	
	Prepared	Checked	Approved	Checked	Approved
June 28, 2010	<i>S. Maezuru</i>	<i>Y. Yamagaki</i>	<i>M. Fujitani</i>	<i>I. Hamada</i>	<i>T. Ito</i>

Spec No. TQ3C-8EAF0-E2DEX65-00	Part No. TCG075VGLDD-C50	Page -
-----------------------------------	-----------------------------	-----------

**Revision record**

Date		Designed by : Engineering dept.			Confirmed by : QA dept.	
		Prepared	Checked	Approved	Checked	Approved
Rev.No.	Date	Page	Descriptions			





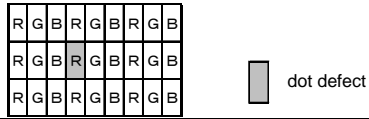
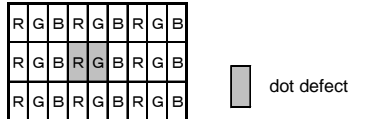
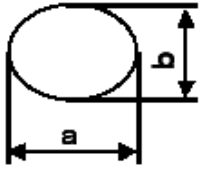
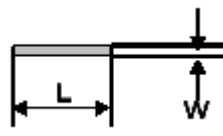

**Visuals specification**

1) Note

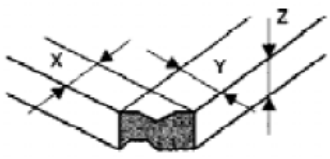
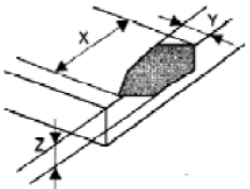
		Note
General		<p>1. Customer identified anomalies not defined within this inspection standard shall be reviewed by Kyocera, and an additional standard shall be determined by mutual consent.</p> <p>2. This inspection standard about the image quality shall be applied to any defect within the <b>active area</b> and shall not be applicable to outside of the area.</p> <p>3. Inspection conditions</p> <p>Luminance : 500 Lux min.</p> <p>Inspection distance : 300 mm.</p> <p>Temperature : 25 ± 5</p> <p>Direction : Directly above</p>
Definition of inspection item	Dot defect	<p>Bright dot defect</p> <p>The dot is constantly “on” when power applied to the LCD, even when all “Black” data sent to the screen. Inspection tool: 5% Transparency neutral density filter. Count dot: If the dot is visible through the filter. Don't count dot: If the dot is not visible through the filter.</p> 
		<p>Black dot defect</p> <p>The dot is constantly “off” when power applied to the LCD, even when all “White” data sent to the screen.</p>
		<p>Adjacent dot</p> <p>Adjacent dot defect is defined as two or more bright dot defects or black dot defects.</p> 
	External inspection	<p>Bubble, Scratch, Foreign particle (Polarizer, Cell, Backlight)</p> <p>Visible operating (all pixels “Black” or “White”) and non operating.</p>
		<p>Appearance inspection</p> <p>Does not satisfy the value at the spec.</p>
	Others	<p>CFL wire</p> <p>Damaged to the CFL wires connector, pin, functional failure or appearance failure.</p>
	Definition of size	<p>Definition of circle size</p>  <p><math>d = (a + b)/2</math></p> <p>Definition of linear size</p> 

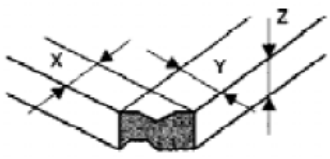
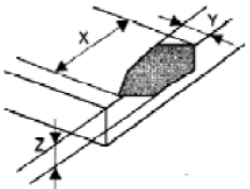
2) Standard

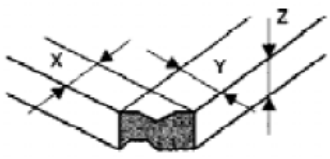
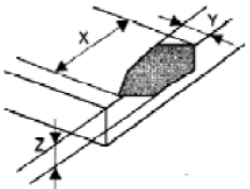
Classification		Inspection item	Judgement standard																										
Defect (in LCD glass)	Dot defect	Bright dot defect	Acceptable number : 4 Bright dot spacing : 5 mm or more																										
		Black dot defect	Acceptable number : 5 Black dot spacing : 5 mm or more																										
		2 dot join	Bright dot defect	Acceptable number : 2																									
			Black dot defect	Acceptable number : 3																									
		3 or more dots join	Acceptable number : 0																										
		Total dot defects	Acceptable number : 5 Max																										
	Others	White dot, Dark dot (Circle)	<table border="1"> <thead> <tr> <th colspan="2">Size (mm)</th> <th>Acceptable number</th> </tr> </thead> <tbody> <tr> <td>d</td> <td>0.2</td> <td>(Neglected)</td> </tr> <tr> <td>0.2 &lt; d</td> <td>0.4</td> <td>5</td> </tr> <tr> <td>0.4 &lt; d</td> <td>0.5</td> <td>3</td> </tr> <tr> <td>0.5 &lt; d</td> <td></td> <td>0</td> </tr> </tbody> </table>			Size (mm)		Acceptable number	d	0.2	(Neglected)	0.2 < d	0.4	5	0.4 < d	0.5	3	0.5 < d		0									
Size (mm)		Acceptable number																											
d	0.2	(Neglected)																											
0.2 < d	0.4	5																											
0.4 < d	0.5	3																											
0.5 < d		0																											
External inspection (Defect on Polarizer or between Polarizer and LCD glass)	Polarizer (Scratch)	<table border="1"> <thead> <tr> <th colspan="2">Width (mm)</th> <th colspan="2">Length (mm)</th> <th>Acceptable number</th> </tr> </thead> <tbody> <tr> <td>W</td> <td>0.1</td> <td colspan="2">-</td> <td>(Neglected)</td> </tr> <tr> <td rowspan="2">0.1 &lt; W</td> <td rowspan="2">0.3</td> <td colspan="2">L 5.0</td> <td>(Neglected)</td> </tr> <tr> <td colspan="2">5.0 &lt; L</td> <td>0</td> </tr> <tr> <td colspan="2">0.3 &lt; W</td> <td colspan="2">-</td> <td>0</td> </tr> </tbody> </table>			Width (mm)		Length (mm)		Acceptable number	W	0.1	-		(Neglected)	0.1 < W	0.3	L 5.0		(Neglected)	5.0 < L		0	0.3 < W		-		0		
		Width (mm)		Length (mm)		Acceptable number																							
		W	0.1	-		(Neglected)																							
		0.1 < W	0.3	L 5.0		(Neglected)																							
	5.0 < L			0																									
	0.3 < W		-		0																								
	Polarizer (Bubble)	<table border="1"> <thead> <tr> <th colspan="2">Size (mm)</th> <th>Acceptable number</th> </tr> </thead> <tbody> <tr> <td>d</td> <td>0.2</td> <td>(Neglected)</td> </tr> <tr> <td>0.2 &lt; d</td> <td>0.3</td> <td>5</td> </tr> <tr> <td>0.3 &lt; d</td> <td>0.5</td> <td>3</td> </tr> <tr> <td>0.5 &lt; d</td> <td></td> <td>0</td> </tr> </tbody> </table>			Size (mm)		Acceptable number	d	0.2	(Neglected)	0.2 < d	0.3	5	0.3 < d	0.5	3	0.5 < d		0										
		Size (mm)		Acceptable number																									
		d	0.2	(Neglected)																									
		0.2 < d	0.3	5																									
0.3 < d	0.5	3																											
0.5 < d		0																											
Foreign particle (Circular shape)	<table border="1"> <thead> <tr> <th colspan="2">Size (mm)</th> <th>Acceptable number</th> </tr> </thead> <tbody> <tr> <td>d</td> <td>0.2</td> <td>(Neglected)</td> </tr> <tr> <td>0.2 &lt; d</td> <td>0.4</td> <td>5</td> </tr> <tr> <td>0.4 &lt; d</td> <td>0.5</td> <td>3</td> </tr> <tr> <td>0.5 &lt; d</td> <td></td> <td>0</td> </tr> </tbody> </table>			Size (mm)		Acceptable number	d	0.2	(Neglected)	0.2 < d	0.4	5	0.4 < d	0.5	3	0.5 < d		0											
	Size (mm)		Acceptable number																										
	d	0.2	(Neglected)																										
	0.2 < d	0.4	5																										
0.4 < d	0.5	3																											
0.5 < d		0																											
Foreign particle (Linear shape) Scratch	<table border="1"> <thead> <tr> <th colspan="2">Width (mm)</th> <th colspan="2">Length (mm)</th> <th>Acceptable number</th> </tr> </thead> <tbody> <tr> <td>W</td> <td>0.03</td> <td colspan="2">-</td> <td>(Neglected)</td> </tr> <tr> <td rowspan="3">0.03 &lt; W</td> <td rowspan="3">0.1</td> <td colspan="2">L 2.0</td> <td>(Neglected)</td> </tr> <tr> <td colspan="2">2.0 &lt; L 4.0</td> <td>3</td> </tr> <tr> <td colspan="2">4.0 &lt; L</td> <td>0</td> </tr> <tr> <td colspan="2">0.1 &lt; W</td> <td colspan="2">-</td> <td>(According to circular shape)</td> </tr> </tbody> </table>			Width (mm)		Length (mm)		Acceptable number	W	0.03	-		(Neglected)	0.03 < W	0.1	L 2.0		(Neglected)	2.0 < L 4.0		3	4.0 < L		0	0.1 < W		-		(According to circular shape)
	Width (mm)		Length (mm)		Acceptable number																								
	W	0.03	-		(Neglected)																								
	0.03 < W	0.1	L 2.0		(Neglected)																								
			2.0 < L 4.0		3																								
4.0 < L			0																										
0.1 < W		-		(According to circular shape)																									

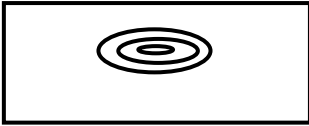
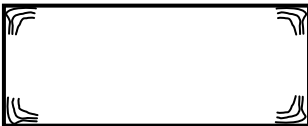
Inspection item	Judgement standard																															
Scratch, Foreign particle (Touch screen portion)	<p>( W = Width, L = Length, D = Diameter = (major axis + minor axis)/ 2 )</p> <table border="1" data-bbox="453 349 1445 712"> <thead> <tr> <th>Item</th> <th>Width(mm)</th> <th>Length(mm)</th> <th>Acceptable number</th> </tr> </thead> <tbody> <tr> <td rowspan="4">Scratch</td> <td>d 0.03</td> <td>L 20</td> <td>Neglected</td> </tr> <tr> <td>0.03 &lt; d 0.05</td> <td>L 10</td> <td>2pcs within φ20mm</td> </tr> <tr> <td>0.05 &lt; d 0.08</td> <td>L 6</td> <td>2pcs within φ20mm</td> </tr> <tr> <td>0.08 &lt; d 0.1</td> <td>L 4</td> <td>1pcs within φ30mm</td> </tr> <tr> <td rowspan="2">Foreign ( line like )</td> <td>W 0.05</td> <td>Neglected</td> <td>Neglected</td> </tr> <tr> <td>0.05 &lt; W 0.1</td> <td>L 5</td> <td>2pcs within 30mm</td> </tr> <tr> <td rowspan="2">Foreign ( circle like )</td> <td>D 0.2</td> <td></td> <td>Neglected</td> </tr> <tr> <td>0.2 &lt; D 0.3</td> <td></td> <td>2pcs within 30mm</td> </tr> </tbody> </table> <p>Above are applied to the visible area. Unless there are foreign particle and damage affected seriously to the electrical performance out of the active area, we approve of this product.</p>	Item	Width(mm)	Length(mm)	Acceptable number	Scratch	d 0.03	L 20	Neglected	0.03 < d 0.05	L 10	2pcs within φ20mm	0.05 < d 0.08	L 6	2pcs within φ20mm	0.08 < d 0.1	L 4	1pcs within φ30mm	Foreign ( line like )	W 0.05	Neglected	Neglected	0.05 < W 0.1	L 5	2pcs within 30mm	Foreign ( circle like )	D 0.2		Neglected	0.2 < D 0.3		2pcs within 30mm
Item	Width(mm)	Length(mm)	Acceptable number																													
Scratch	d 0.03	L 20	Neglected																													
	0.03 < d 0.05	L 10	2pcs within φ20mm																													
	0.05 < d 0.08	L 6	2pcs within φ20mm																													
	0.08 < d 0.1	L 4	1pcs within φ30mm																													
Foreign ( line like )	W 0.05	Neglected	Neglected																													
	0.05 < W 0.1	L 5	2pcs within 30mm																													
Foreign ( circle like )	D 0.2		Neglected																													
	0.2 < D 0.3		2pcs within 30mm																													
Glass crack (Touch screen portion)	<table border="1" data-bbox="453 853 1445 1621"> <thead> <tr> <th>Item</th> <th>Size (mm)</th> <th>Acceptable number</th> </tr> </thead> <tbody> <tr> <td rowspan="3">Corner crack</td> <td rowspan="3">  </td> <td>X 3</td> <td rowspan="3">2 pcs /panel</td> </tr> <tr> <td>Y 3</td> </tr> <tr> <td>Z &lt; t</td> </tr> <tr> <td rowspan="3">Crack in other area than in corner</td> <td rowspan="3">  </td> <td>X 5</td> <td rowspan="3">2 pcs /side</td> </tr> <tr> <td>Y 1.5</td> </tr> <tr> <td>Z &lt; t</td> </tr> <tr> <td>Progressive crack</td> <td>  </td> <td>0 pcs (NG even 1pcs)</td> </tr> </tbody> </table> <p>Above are applied to the visible area. Unless there are foreign particle and damage affected seriously to the electrical performance out of the active area, we approve of this product.</p>	Item	Size (mm)	Acceptable number	Corner crack		X 3	2 pcs /panel	Y 3	Z < t	Crack in other area than in corner		X 5	2 pcs /side	Y 1.5	Z < t	Progressive crack		0 pcs (NG even 1pcs)													
Item	Size (mm)	Acceptable number																														
Corner crack		X 3	2 pcs /panel																													
		Y 3																														
		Z < t																														
Crack in other area than in corner		X 5	2 pcs /side																													
		Y 1.5																														
		Z < t																														
Progressive crack		0 pcs (NG even 1pcs)																														
Newton's ring	<p>All Newton Rings in the center of the screen must be rejected. Border around the screen are permitted.</p> <div style="display: flex; justify-content: space-around; align-items: center;"> <div style="text-align: center;">  <p>NG</p> </div> <div style="text-align: center;">  <p>OK</p> </div> </div>																															